

PER IL MONTAGGIO DI UTENSILI CON GAMBO CONICO MORSE.

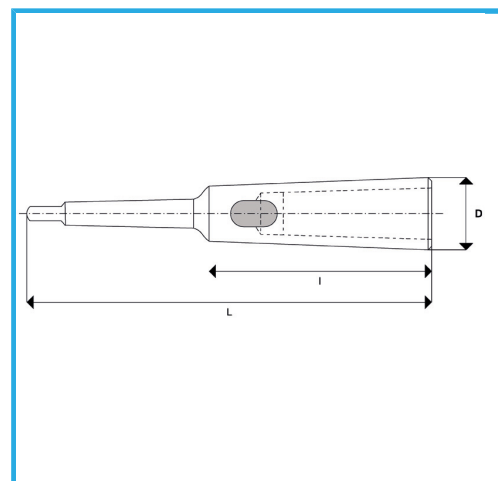

€27,10



CM Esterno	3
CM Interno	2
L	194 mm
I	100 mm
D	30 mm
Peso lordo	0,69 kg
Dimensioni imballo	205x45x45 h mm
Codice EAN	8012667349622



Scatola



Temprato



Acciaio



Rettificato