

ADATTI PER LA RIGENERAZIONE DELLE FILETTATURE O PER OTTENERE DELLE MASCHIATURE MOLTO RESISTENTI IN MATERIALI TENERI.

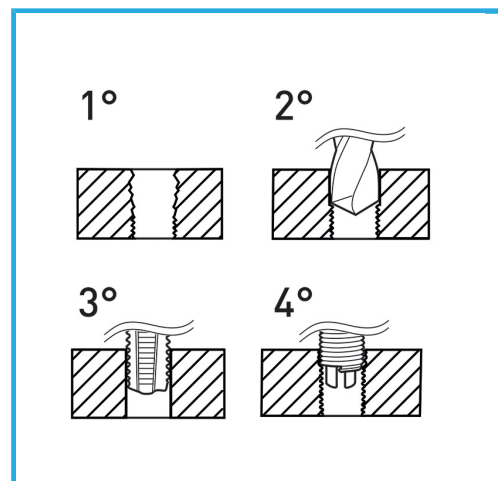

€67,10



Filetto	5/8" x 11
Punta	-
Maschi STI	E011/BSW5/8M
Utensile montaggio	E011/U18
Attrezzo rottura	-
Inserti filettati	E010/BSW5/8E15
Quantità inserti	10
Dimensioni imballo	170x130x40 h mm
Peso lordo	0,71 kg
Codice EAN	8012667366117



Append.

HSS



INOX