

DIN 2080, BALANCED CHUCK BODY, WITH EXTRACTION SLOT FOR TOOLS. BALANCING 12.000 RPM.

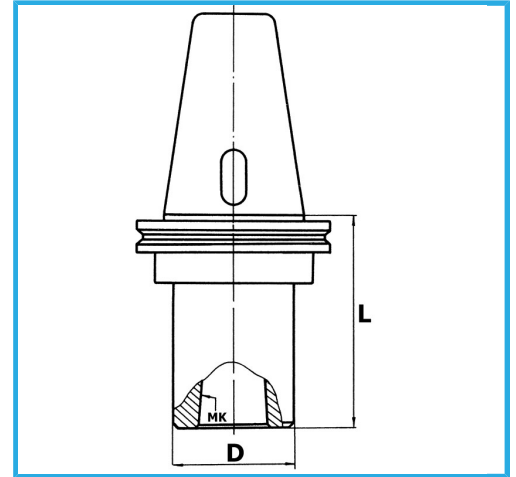

ISO	50
MT	3
D	40 mm
L	65 mm
Gross weight	0,97 kg
EAN Code	8012667407209



Box



Grounded