

BALANCED CHUCK BODY

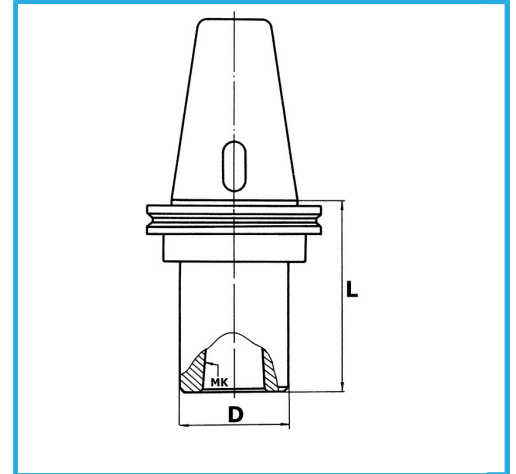

€137,00



ISO	50
MT	3
D	40 mm
L	50 mm
Balancing rpm	12000
EAN Code	8012667007874

 DIN 69871/A