

MAS-403 BT, CON CUERPO EQUILIBRADO, PARA FRESAS CILÍNDRICAS SEGÚN DIN 481, PARA FRESAS CON RANURA LONGITUDINAL DIN...

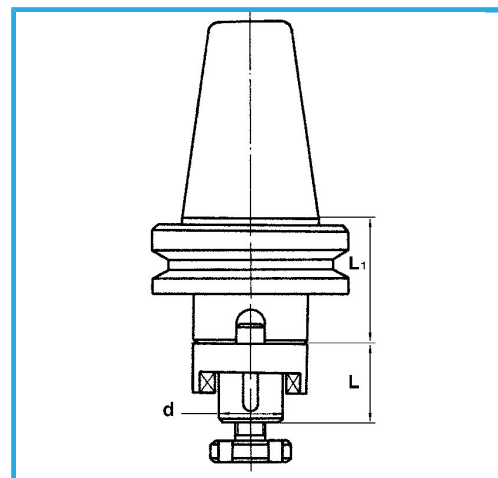

€177,00



Buril	50
d - h6	27 mm
L	33 mm
L1	35 mm
Peso bruto	4,36 kg
Codigo de barras	8012667008598



Caja



Templado



Rectificado



18Ni
CrMo5