

DIN 2080, CON CUERPO EQUILIBRADO, PARA FRESAS (WELDON)
SEGÚN DIN 1835 B Y DIN 6535 HB. SE SUMINISTRA CON TORNILLO
DE...

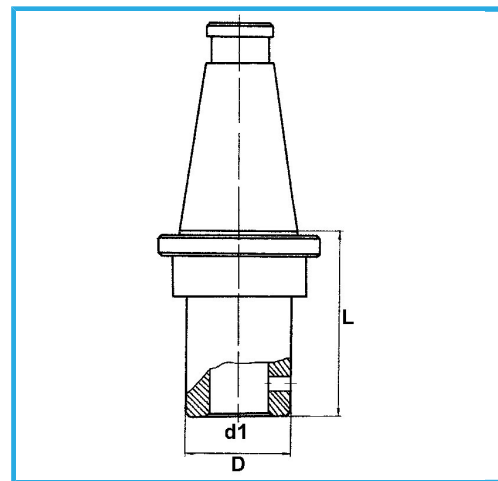

€154,00



ISO	50
d1 - h6	32 mm
D	72 mm
L	80 mm
Peso bruto	4,16 kg
Codigo de barras	8012667187606



Caja



Rectificado

18Ni
CrMo5