

DA 19,05 MM PER TRAPANI MAGNETICI E TRAPANI A COLONNA, PER LAVORAZIONE DI MATERIALI CON RESISTENZA R= 1200 N/MM2

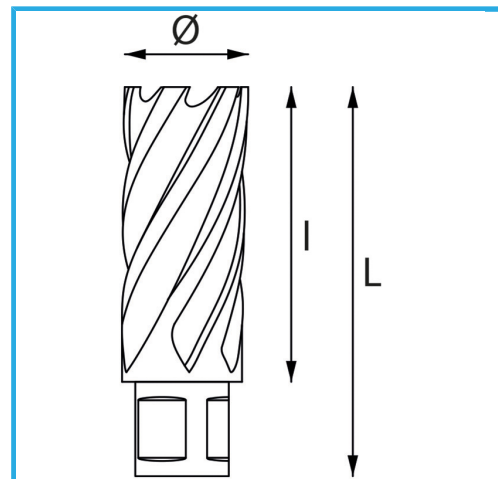

€111,00



Ø	41 mm
Capacità di taglio	30 mm
Lunghezza totale	62 mm
Codice EAN	8012667291532

 HSS - Co 5%